

















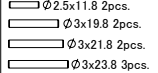









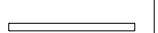
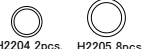









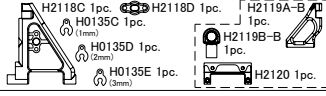
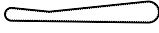





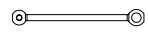











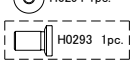
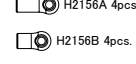
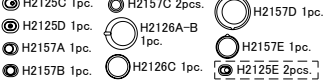







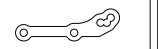

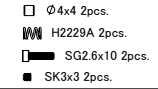
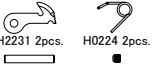

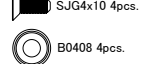



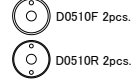

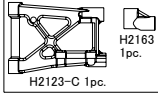
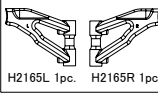
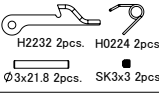

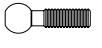
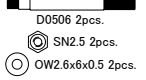

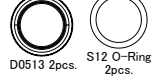



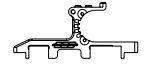



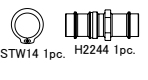
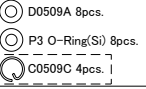

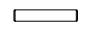



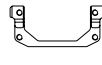
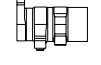

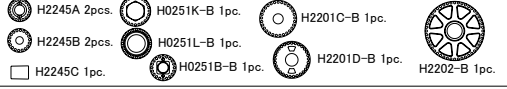
MRX SPARE PARTS LIST (H2009) - 1/2

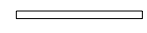
Rev.2602

A2210a (1pc.) SPUR GEAR SHAFT 	A2227a (10pcs.) SHIM 3x5x0.2 	A2601b (2pcs.) BEARING 3x6x2.5 	E2817a (10pcs.) P2 O-Ring 	H0142-Ba (1pc.) RADIO TRAY MOUNT 	H0144a (1SET) KING PIN BALL CUP H0144 8pcs. H0254 2pcs. 	H0801a (2pcs.) STEERING ROD 	H0853b (10pcs.) PIN 3x1.6 	H0854a (1SET) PIN SET Ø2.5x11.8 2pcs. Ø3x19.8 2pcs. Ø3x21.8 2pcs. Ø3x23.8 3pcs. 	H2176 (1pc.) UPRIGHT INSERT R 	H2178 (2pcs.) TURNBUCKLE ARB 	H2179 (1pc.) SHOCK MOUNT F 
A2601/1a (10pcs.) BEARING 3x6x2.5 	A2802-Ba (1SET) BALL JOINTS A2802C 4pcs. A2124 2pcs. A2802A 1pc. A2802B 4pcs. A2110F 4pcs. 		H0145 (2pcs.) ADJUST NUT 	H0181A-Gb (8pcs.) SPACER 0.5mm 	H0181B-Gb (8pcs.) SPACER 1mm 	H0858a (10pcs.) BALL LINK 6mm 	H2105b (2pcs.) LOWER ARM SHAFT F 	H2106b (2pcs.) UPPER ARM SHAFT F 	H2204a (1SET) SPACER WHEEL AXLE H2204 2pcs. H2205 8pcs. 	H2211b (1pc.) FRONT BELT 	H2213a (2pcs.) OUTDRIVE FRONT 
A2803b (10pcs.) SHIM 3x6x1 	A2804b (10pcs.) SHIM 3x6x2 	A2807b (1pc.) AL TURNBUCKLE 	H0181C-Gb (8pcs.) SPACER 2mm 	H0181D-Gb (8pcs.) SPACER 3mm 	H0240b (1pc.) REAR BELT S 8mm 	H2116a (2pcs.) ARB STOPPER 	H2118-Da (1SET) FRONT SUSPENSION ARM H2118C 1pc. H2118D 1pc. H2119A-B 1pc. H0135C 1pc. H0135D 1pc. H0135E 1pc. H2119B 1pc. H2120 1pc. 		H2216b (1pc.) SIDE BELT RUBBER 	H2218a (2pcs.) WHEEL AXLE F 	H2219a (2pcs.) WHEEL AXLE R 
A2808b (2pcs.) AL TURNBUCKLE M4 	A2811b (10pcs.) SHIM 3x6x0.5 	A2812a (2pcs.) AL TURNBUCKLE M4 	H0268a (4pcs.) AXLE WASHER 	H0272-Ba (2pcs.) DRIVESHAFT FRONT 	H0273a (2pcs.) JOINT SHAFT FOR UNL. 	H2139b (1pc.) FRONT ARB 2.3mm 	H2151-C (1pc.) UPPER BULKHEAD R 	H2154b (1pc.) REAR ARB 2.9mm 	H2220a (1pc.) BELT TENSIONER PLATE 	H2222b (1pc.) REAR SOLID AXLE 	H2223a (2pcs.) REAR DRIVE SHAFT 
B0407 (15pcs.) FLAT WASHER 3mm 	B0408 (15pcs.) FLAT WASHER 4mm 	B0413 (1pc.) SILICON PIPE GREY 	H0274a (10pcs.) PIN 2.5x11.8 	H0288a (1pc.) 1ST GEAR HOUSING 	H0293a (1SET) BELT TENSIONER NUT H0294 1pc. H0293 1pc. 	H2156a (1SET) BALL LINK 7mm H2156A 4pcs. H2156B 4pcs. 	H2157 (1SET) ECCENTRIC HUB H2157C 2pcs. H2157D 1pc. H2157E 1pc. H2157A 1pc. H2157B 1pc. H2126A-B 1pc. H2126C 1pc. H2125E 2pcs. 		H2224a (1pc.) PULLEY ADAPTER 	H2226a (1pc.) 2-SPEED BELL 	H2227b (2pcs.) 2-SPEED SHOE 
B0422a (8pcs.) BODY CLIP S 	B0432 (5pcs.) ANTENNA CAP 	C0602/1 (2pcs.) BEARING 5x8x2.5 	H0362a (1SET) SERVO MOUNT PARTS H0362A 1pc. H0362G 2pcs. H0362B 2pcs. H0362D 2pcs. H0362F 2pcs. H0362C 2pcs. H0362E 2pcs. 			H2158-B (1pc.) LOWER BULKHEAD R 	H2159-B (1pc.) SHOCK MOUNT R 	H2161L/Rb (1SET) FRONT UPRIGHT H2161R 1pc. H2161L 1pc. 	H2228b (1pc.) ROLLER BELT TENSION 	H2229-B (1SET) 2-SPEED PARTS Ø4x4 2pcs. H2229A 2pcs. SG2.6x10 2pcs. SK3x3 2pcs. 	H2231a (1SET) WHEEL LEVER F H2231 2pcs. H0224 2pcs. Ø3x19.8 2pcs. SK3x3 2pcs. 
C0602/2b (10pcs.) BEARING 5x8x2.5 	C0723a (1SET) SCREW & WASHER SJG4x10 4pcs. B0408 4pcs. 	D0104Ra (2pcs.) LOWER ARM PIN R 	H0368 (10pcs.) GROMMET 	H0471a (4pcs.) SCREW BODYMOUNT 	H0510b (1SET) DAMPER PISTON D0510F 2pcs. D0510R 2pcs. 	H2162b (1pc.) UPRIGHT INSERT F 	H2163b (1SET) SUSPENSION ARM R H2163 1pc. H2123-C 1pc. 	H2165L/Rb (1SET) UPPER ARM FRONT H2165L 1pc. H2165R 1pc. 	H2232a (1SET) WHEEL LEVER R H2232 2pcs. H0224 2pcs. Ø3x21.8 2pcs. SK3x3 2pcs. 	H2233a (1pc.) PINION 19T 	H2235a (1pc.) PINION 24T 
D0105Ra (2pcs.) KING PIN 	D0506a (1/2SET) DAMPER SHAFT D0506 2pcs. SN2.5 2pcs. OW2.6x6x0.5 2pcs. 	D0508a (8pcs.) SHOCK DIAPHRAGM 	H0513 (1SET) SPRING ADJUSTER D0513 2pcs. S12 O-Ring 2pcs. 	H0526b (2pcs.) FRONT SPRING 1.9x6.0 	H0530b (2pcs.) REAR SPRING 1.9x7.0 	H2167 (1pc.) ROLL OVER BAR 	H2169 (1pc.) LOWER BULKHEAD F 	H2170 (1pc.) UPPER BULKHEAD F 	H2238 (1pc.) SPUR GEAR 6T 	H2241 (1pc.) SPUR GEAR 5T 	H2244 (1SET) FRONT ONEWAY STW14 1pc. H2244 1pc. 
D0509b (1SET) O-RING SET D0509A 8pcs. P3 O-Ring(SI) 8pcs. C0509C 4pcs. 	D0807a (8pcs.) BODY CLIP L 	E0210a (8pcs.) PIN 3x16.8 	H0554a (2pcs.) DAMPER CAP 	H0563a (2pcs.) OIL SEAL CAP 	H0608 (2pcs.) BEARING 2nd GEAR 	H2171 (1pc.) UPPER ARM BRACKET 	H2172 (1pc.) MIDDLE SHAFT BRACKET 	H2173L (1pc.) GEARSHAFT BULKHEAD L 	H2245 (1SET) PULLEY SET H2245A 2pcs. H0251K-B 1pc. H2201C-B 1pc. H2245B 2pcs. H0251L-B 1pc. H2201D-B 1pc. H2202-B 1pc. H2245C 1pc. H0251B 1pc. 		
E0322a (1pc.) RADIO BOX GROMMET 	E0829b (4pcs.) ARB LINK BALL 	E2808a (4pcs.) ANTENNA PIPE 	H0704 (1pc.) ENGINE NUT 	H0753 (1pc.) SPRING CUP 	H0755 (1pc.) SPRING ADJUST NUT 	H2173R (1pc.) GEARSHAFT BULKHEAD R 	H2174 (1pc.) BRACE 	H2175 (1pc.) REAR UPRIGHT 	H2246 (1pc.) MIDDLE SHAFT 	H2247 (1pc.) 2-SPEED ADAPTER 	H2248 (1pc.) GEARSHAFT 

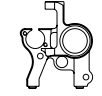
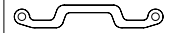
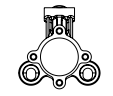
H2252 (10pcs.)
PIN 2.5x12.6

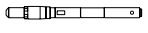







H2304a (1SET)
BRAKE RETURN SPRING

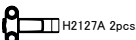

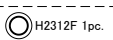

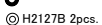

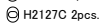
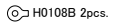
H2312-Bb (1SET)
SERVO SAVER ARM & PARTS

H2313a (1pc.)
BATTERY PLATE

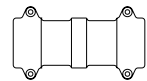

H2319b (1SET)
BRAKE CAM/PISTON





H2320a (2pcs.)
BRAKE PAD



H2321a (1pc.)
BRAKE DISK

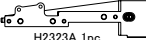

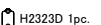
H2323a (1SET)
RC MODULE

H2326 (1SET)
STEERING BRACKET





H2327 (1SET)
STEERING LEVER & ARB LINK





H2402-D (1pc.)
FRONT BUMPER



H2415b (1pc.)
CENTERING SHAFT R



H2423 (2pcs.)
FRONT BODYPOST



H2424 (1pc.)
FRONT BODYPLATE



H2425 (1pc.)
UPPERDECK

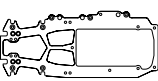

H2427a (1pc.)
CHASSIS

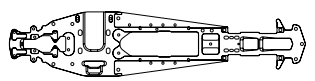





H2427b (1pc.)
CHASSIS STIFFENER



H2428 (1pc.)
REAR BODYMOUNT



H2429 (1SET)
REAR BODYMOUNT ARM

H2505b (2pcs.)
REAR SHOCK UNIBALL



H2506b (2pcs.)
ARB LINK BALL



H2511b (2pcs.)
SHOCK CASE









H2514a (1SET)
DAMPER PARTS





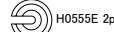
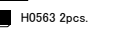
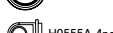
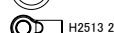
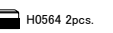
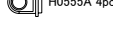
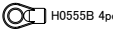
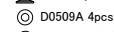
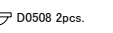

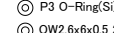
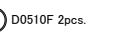
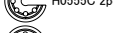
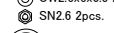
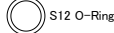
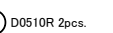
H2515a (1SET)
DAMPER SET

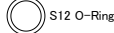
H2518-B (1pc.)
SHOCK TOWER R



H2519 (1pc.)
FRONT SHOCK MOUNT



H2602a (2pcs.)
BEARING 8x14x4



H2604a (1pc.)
TRUST BEARING 5x10



H2605a (2pcs.)
BEARING 12x18x4



H2605/1a (10pcs.)
BEARING 12x18x4



H2701 (1pc.)
CLUTCH FLYWHEEL



H2702 (1pc.)
PRESSURE PLATE



H2706 (1pc.)
CLUTCH SPRING



H2713a (1SET)
CLUTCH WASHER SET



H2719a (3pcs.)
CLUTCH FLYWEIGHT



H2720b (1pc.)
CLUTCH BELL



H2721a (1pc.)
BEARING STOPPER









H2722c (1pc.)
CLUTCH SHOE



H2724a (1pc.)
TAPER CONE

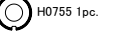

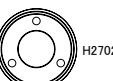
H2723c (1SET)
CLUTCH SET V2

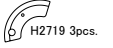
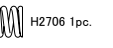
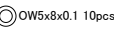
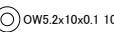
H2725 (2pcs.)
MOTORMOUNT







H2802-B (1SET)
FUEL TANK MOUNT





H2804-Ab (2pcs.)
BUSHING

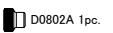
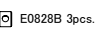
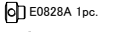
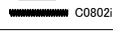

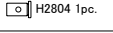
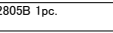
H2804-Bb (1SET)
LINKAGE PARTS

H2810a (4pcs.)
O-RING FUEL TANK



H2811 (1pc.)
FUEL TANK

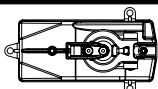

H2902a (1pc.)
MUFFLER MOUNT



P0402a (1pc.)
DECAL



T0215 (8pcs.)
PIN 2x9.8



T2114b (2pcs.)
ARB STOPPER



T2116b (2pcs.)
PIVOT BALL



T2117b (2pcs.)
ADJUST NUT S









T2148b (2pcs.)
PIVOT BALL AL 7mm

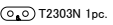
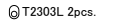

T2158b (2pcs.)
ARB BALL

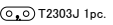
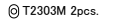
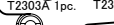

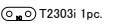
T2303-Cb (1SET)
SERVO SAVER PARTS

T2601a (2pcs.)
BEARING 10x15x4



T2601/1a (10pcs.)
BEARING 10x15x4



T2803b (4pcs.)
UNIBALL 5mm



T2804L-Ba (10pcs.)
BALL LINK SET LONG



T2804S-Ba (8pcs.)
BALL LINK SET SHORT















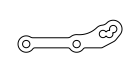
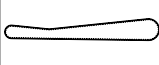





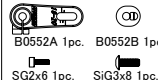
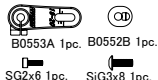
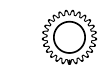

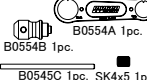



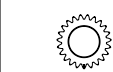
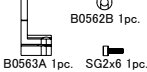

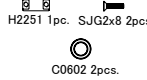
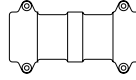













T2805b (4pcs.)
PIVOT BALL AL 6mm

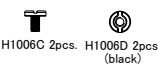

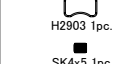
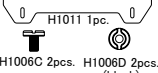
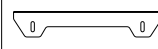
A FEW SETS CONTAIN PARTS NOT USED IN MRX7. THEREFORE THESE ARE SHOWN.

NOT USED IN THIS KIT

MRX **OPTIONAL PARTS LIST (H2009)** Rev.2602

A2422-Ba (1pc.) WEIGHT 10g 	A2428-B (1pc.) WEIGHT 5g 	H2155b (1pc.) REAR ARB 3.0 	H2168a (1pc.) SHOCK MOUNT R AL 	H2214a (1pc.) SIDE BELT PU 		
A2435a (1SET) BODY SUPPORTS 		A2813a (4pcs.) ALU BALL 5mm 		H2215b (1pc.) FRONT BELT RUBBER 	H2217b (1pc.) REAR BELT RUBBER 	H2234a (1pc.) PINION 20T 
B0245 (1set.) ALIGNMENT BLOCK FOR B0236/MRX7 	B0552 (1set.) 23T SERVO HORN 	B0553 (1set.) 25T SERVO HORN 	H2236a (1pc.) PINION 25T 	H2237 (1pc.) SPUR GEAR 60T 	H2239 (1pc.) SPUR GEAR 62T 	
B0554a (1set.) PINION GEAR TOOL 	B0557 (1pc.) TURNBUCKLE TOOL 	B0562 (1SET) 23T SERVO ARM ST. 	H2240 (1pc.) SPUR GEAR 56T 	H2242 (1pc.) SPUR GEAR 58T 	H2243a (1pc.) PINION 23T 	
B0563 (1SET) 25T SERVO ARM ST. 	H0187 (2pcs.) TL. KINGPIN BALL 	H0187/1 (8pcs.) TL. KINGPIN BALL 	H2251 (1SET) REAR BELT GUIDE 	H2315a (1pc.) BATTERY PLATE CFRP 	H2402-DH (1pc.) FRONT BUMPER HARD 	
H0470b (2pcs.) REAR BODY MOUNT STOPPER 	H0511 (2pcs.) FRONT SPRING 1.9 BL 	H0515a (2pcs.) FRONT SPRING 1.8-5.0 	H2412a (1pc.) CHASSIS WEIGHT 18g 	H2507a (2pcs.) DAMPER PISTON 3H 	H2509b (2pcs.) AL SPRING SHEET F 	
H0525b (2pcs.) FRONT SPRING 1.8-6.0 	H0529b (2pcs.) REAR SPRING 1.8-7.0 	H0558 (2pcs.) DAMPER PISTON 1.2 	H2510b (2pcs.) AL SPRING SHEET R 	H2517a (2pcs.) FRONT SPRING 1.9-6.5 	H2521 (2pcs.) REAR SPRING 1.9-6.5 	
H0559 (2pcs.) DAMPER PISTON 1.3 	H0862a (2pcs.) TL. TURNBUCKLE ST. 	H1006/1c (1SET) SCREW REAR WING 	H2709-Ba (1pc.) CLUTCH SHOE BLACK 	H2813 (1SET) FUEL TANK CAP. SPACER 	H2903a (1SET) MUFFLER STOPPER 	
H1010/1 (1SET) REAR WING & SCREW 	H1011 (1pc.) REAR WING 	H2138b (1pc.) FRONT ARB 2.2 	P0403a (1pc.) DECAL METALLIC 	T2159a (2pcs.) KING PIN PIVOT BALL 		
H2140b (1pc.) FRONT ARB 2.4 	H2141b (1pc.) FRONT ARB 2.5 	H2153b (1pc.) REAR ARB 2.8 				

 **A FEW SETS CONTAIN PARTS NOT USED IN MRX7. THEREFORE THESE ARE SHOWN.**
 **NOT USED IN THIS KIT**